

# Metal Wireway

UL 870 AND CSA C22.2 NO. 26, MEETS ELEVATOR INDUSTRY STANDARDS

## Galvanized steel trough



Part Number	Dimension A inches	Dimension B inches	Dimension C inches
UGTR 2525120CSA	2-1/2	2-1/2	120
UGTR 254120CSA	2-1/2	4	120
UGTR 256120CSA	2-1/2	6	120
UGTR 258120CSA	2-1/2	8	120
UGTR 44120CSA	4	4	120
UGTR 46120CSA	4	6	120
UGTR 48120CSA	4	8	120
UGTR 66120CSA	6	6	120
UGTR 88120CSA	8	8	120

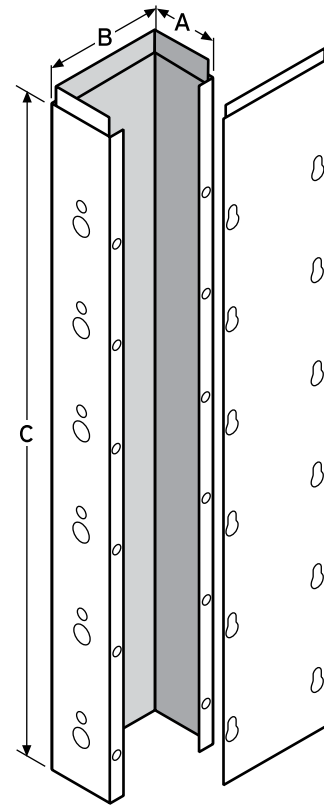

Wireway comes with two five-foot covers, #10-5/16 hexhead screws and screw protection and spot-welded coupling on one end.

Special size trough and trough without knockouts are available with short lead times. Call Draka Elevator at 1-877-372-5237 for further information.

Tolerances: Inside dimensions from 0 to + 1/16 in.  
joints, corners and adjoining edges to + 1/32 in.  
screw & hole placement to + 1/32 in.

Materials: Hot-dipped, mill-galvanized sheet metal

General: Uniform knockouts 1/2 in. and 3/4 in. every 12 in. EXCEPT FOR UGTR 254120CSA which has knockouts 1/2 in., 3/4 in. & 1 in. every 12 in.

## Covers and screws

Part Number	Description	Dimension B inches	Dimension C inches
C U25	Cover	2-1/2	60
C U44	Cover	4	60
C U66	Cover	6	60
C U88	Cover	8	60
59-020	Cover screw, #10-32 x 1/2 in.		

## Wireway nuts & bolts - used to attach fittings to wireway

Part Number	Size inches	Standard Packaging
26-006A	1/4 x 1/2 nut & bolt	25
26-006B	1/4 x 1/2 nut & bolt	50
26-006C	1/4 x 1/2 nut & bolt	100

## Plastic U-channel

Part Number	Description
19-003	Plastic U-channel, available in 100 ft. rolls

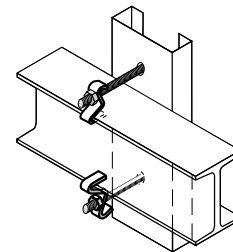

## Trough mounting bracket kit - used to attach trough to steel I-beams

Part Number	Description	Quantity
TR-MTG-KIT	Bracket, with 5 in. mounting bolt, nut and two washers	1

## Strain bars

Part Number	For trough width inches
STB 25	2-1/2
STB 4	4
STB 6	6
STB 8	8

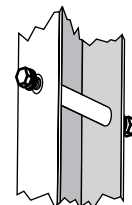

The NEC requires that strain bars be used to support wire every 100 ft. in trough.

# Metal Wireway

UL 870 AND CSA C22.2 NO. 26

## 90° elbows/Type C



Part Number	Dimension A inches	Dimension B inches	For use with Trough P/N
UL90 2525CSA	2-1/2	2-1/2	UGTR 2525120CSA
UL90 254CSA	2-1/2	4	UGTR 254120CSA
UL90 256CSA	2-1/2	6	UGTR 256120CSA
UL90 258CSA	2-1/2	8	UGTR 258120CSA
UL90 44CSA	4	4	UGTR 44120CSA
UL90 46CSA	4	6	UGTR 46120CSA
UL90 48CSA	4	8	UGTR 48120CSA
UL90 66CSA	6	6	UGTR 66120CSA
UL90 88CSA	8	8	UGTR 88120CSA

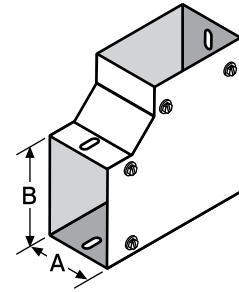

## 90° elbows/Type D



Part Number	Dimension A inches	Dimension B inches	For use with Trough P/N
UL90 425CSA	2-1/2	4	UGTR 254120CSA
UL90 625CSA	2-1/2	6	UGTR 256120CSA
UL90 825CSA	2-1/2	8	UGTR 258120CSA
UL90 64CSA	4	6	UGTR 46120CSA
UL90 84CSA	4	8	UGTR 48120CSA

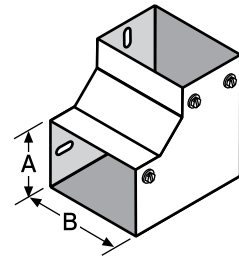

## 45° elbows/Type C



Part Number	Dimension A inches	Dimension B inches	For use with Trough P/N
UL45 2525CSA	2-1/2	2-1/2	UGTR 2525120CSA
UL45 254CSA	2-1/2	4	UGTR 254120CSA
UL45 256CSA	2-1/2	6	UGTR 256120CSA
UL45 258CSA	2-1/2	8	UGTR 258120CSA
UL45 44CSA	4	4	UGTR 44120CSA
UL45 46CSA	4	6	UGTR 46120CSA
UL45 48CSA	4	8	UGTR 48120CSA
UL45 66CSA	6	6	UGTR 66120CSA
UL45 88CSA	8	8	UGTR 88120CSA

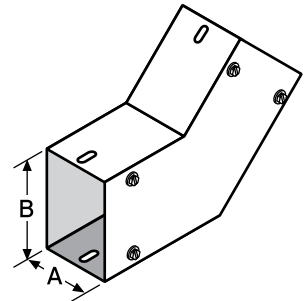

## 45° elbows/Type D



Part Number	Dimension A inches	Dimension B inches	For use with Trough P/N
UL45 425CSA	2-1/2	4	UGTR 254120CSA
UL45 625CSA	2-1/2	6	UGTR 256120CSA
UL45 825CSA	2-1/2	8	UGTR 258120CSA
UL45 64CSA	4	6	UGTR 46120CSA
UL45 84CSA	4	8	UGTR 48120CSA

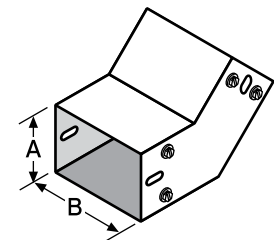

Elbows come with #10-5/16 hexhead screws & screw protection.

Special size trough and trough without knockouts are available with short lead times.  
Call Draka Elevator at 1-877-372-5237 for further information.

Tolerances: Inside dimensions from 0 to + 1/16 in.  
joints, corners and adjoining edges to + 1/32 in.  
screw & hole placement to + 1/32 in.

Materials: Hot-dipped, mill-galvanized sheet metal

General: Connector slots 3/4 x 1/4 in.

# Metal Wireway

UL 870 AND CSA C22.2 NO. 26

## Tees/Type C



Part Number	Dimension A inches	Dimension B inches	For use with Trough P/N
UTEE 2525CSA	2-1/2	2-1/2	UGTR 2525120CSA
UTEE 254CSA	2-1/2	4	UGTR 254120CSA
UTEE 256CSA	2-1/2	6	UGTR 256120CSA
UTEE 258CSA	2-1/2	8	UGTR 258120CSA
UTEE 44CSA	4	4	UGTR 44120CSA
UTEE 46CSA	4	6	UGTR 46120CSA
UTEE 48CSA	4	8	UGTR 48120CSA
UTEE 66CSA	6	6	UGTR 66120CSA
UTEE 88CSA	8	8	UGTR 88120CSA

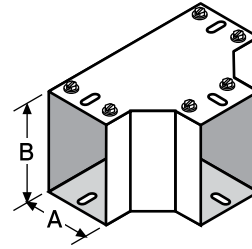

## Tees/Type D



Part Number	Dimension A inches	Dimension B inches	For use with Trough P/N
UTEE 425CSA	2-1/2	4	UGTR 254120CSA
UTEE 625CSA	2-1/2	6	UGTR 256120CSA
UTEE 825CSA	2-1/2	8	UGTR 258120CSA
UTEE 64CSA	4	6	UGTR 46120CSA
UTEE 84CSA	4	8	UGTR 48120CSA

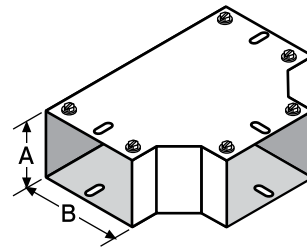

## Crossovers/Type C



Part Number	Dimension A inches	Dimension B inches	For use with Trough P/N
UCRS 2525CSA	2-1/2	2-1/2	UGTR 2525120CSA
UCRS 254CSA	2-1/2	4	UGTR 254120CSA
UCRS 256CSA	2-1/2	6	UGTR 256120CSA
UCRS 258CSA	2-1/2	8	UGTR 258120CSA
UCRS 44CSA	4	4	UGTR 44120CSA
UCRS 46CSA	4	6	UGTR 46120CSA
UCRS 48CSA	4	8	UGTR 48120CSA
UCRS 66CSA	6	6	UGTR 66120CSA
UCRS 88CSA	8	8	UGTR 88120CSA

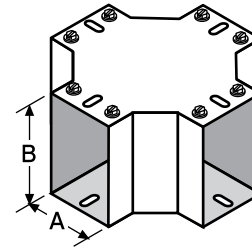

## Crossovers/Type D



Part Number	Dimension A inches	Dimension B inches	For use with Trough P/N
UCRS 425CSA	2-1/2	4	UGTR 254120CSA
UCRS 625CSA	2-1/2	6	UGTR 256120CSA
UCRS 825CSA	2-1/2	8	UGTR 258120CSA
UCRS 64CSA	4	6	UGTR 46120CSA
UCRS 84CSA	4	8	UGTR 48120CSA

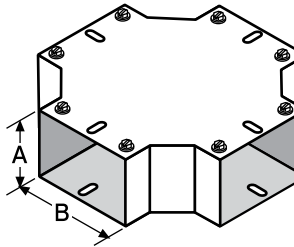

Tees and crossovers come with #10-5/16 hexhead screws and screw protection.

Special size trough and trough without knockouts are available with short lead times. Call Draka Elevator at 1-877-372-5237 for further information.

**Tolerances:** Inside dimensions from 0 to +1/16 in.  
joints, corners and adjoining edges to +1/32 in.  
screw & hole placement to +1/32 in.

**Materials:** Hot-dipped, mill-galvanized sheet metal

**General:** Connector slots 3/4 x 1/4 in.

Wireway and Electrical

# Metal Wireway

UL 870 AND CSA C22.2 NO. 26

## Couplings



Part Number	Dimension A inches	Dimension B inches
UCON 2525CSA	2-1/8	2-7/16
UCON 254CSA	2-1/8	3-15/16
UCON 256CSA	2-1/8	5-15/16
UCON 258CSA	2-1/8	7-15/16
UCON 44CSA	3-5/8	3-15/16
UCON 46CSA	3-5/8	5-15/16
UCON 48CSA	3-5/8	7-15/16
UCON 66CSA	5-5/8	5-15/16
UCON 88CSA	7-5/8	7-15/16

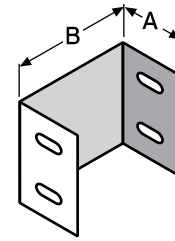

## Panel connectors



Part Number	Dimension A inches	Dimension B inches
UPCN 2525CSA	2-1/8	2-7/16
UPCN 254CSA	2-1/8	3-15/16
UPCN 256CSA	2-1/8	5-15/16
UPCN 258CSA	2-1/8	7-15/16
UPCN 44CSA	3-5/8	3-15/16
UPCN 46CSA	3-5/8	5-15/16
UPCN 48CSA	3-5/8	7-15/16
UPCN 66CSA	5-5/8	5-15/16
UPCN 88CSA	7-5/8	7-15/16

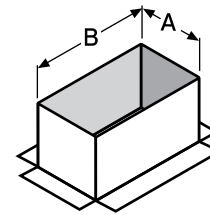

## End plates



Part Number	Dimension A inches	Dimension B inches
UEPT 2525CSA	2-1/8	2-7/16
UEPT 254CSA	2-1/8	3-15/16
UEPT 256CSA	2-1/8	5-15/16
UEPT 258CSA	2-1/8	7-15/16
UEPT 44CSA	3-5/8	3-15/16
UEPT 46CSA	3-5/8	5-15/16
UEPT 48CSA	3-5/8	7-15/16
UEPT 66CSA	5-5/8	5-15/16
UEPT 88CSA	7-5/8	7-15/16

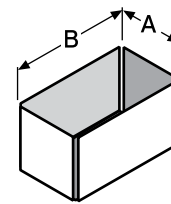

## Insulated bushings



Part Number	Dimension A inches	Dimension B inches
UI SB 2525CSA	2-1/8	2-7/16
UI SB 254CSA	2-1/8	3-15/16
UI SB 256CSA	2-1/8	5-15/16
UI SB 258CSA	2-1/8	7-15/16
UI SB 44CSA	3-5/8	3-15/16
UI SB 46CSA	3-5/8	5-15/16
UI SB 48CSA	3-5/8	7-15/16
UI SB 66CSA	5-5/8	5-15/16
UI SB 88CSA	7-5/8	7-15/16

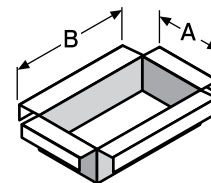

Special size trough and trough without knockouts are available with short lead times.

Call Draka Elevator at 1-877-372-5237 for further information.

# Metal Wireway

UL 870 AND CSA C22.2 NO. 26

## Reducers



Part Number	Adapts from this size... inches	to this size inches
URED 2542525CSA	2-1/2 x 4	2-1/2 x 2-1/2
URED 254256CSA	2-1/2 x 4	2-1/2 x 6
URED 25666CSA	2-1/2 x 6	6 x 6
URED 25888CSA	2-1/2 x 8	8 x 8
URED 442525CSA	4 x 4	2-1/2 x 2-1/2
URED 44254CSA	4 x 4	2-1/2 x 4
URED 44256CSA	4 x 4	2-1/2 x 6
URED 4446CSA	4 x 4	4 x 6
URED 4448CSA	4 x 4	4 x 8
URED 46254CSA	4 x 6	2-1/2 x 4
URED 48254CSA	4 x 8	2-1/2 x 4
URED 6644CSA	6 x 6	4 x 4
URED 6664CSA	6 x 6	6 x 4
URED 8844CSA	8 x 8	4 x 4
URED 25844CSA	2-1/2 x 8	4 x 4
URED 48256CSA	4 x 8	2-1/2 x 6
URED 8848CSA	8 x 8	4 x 8
URED 8866CSA	8 x 8	6 x 6

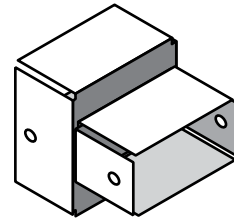

Special size trough and trough without knockouts are available with short lead times. Call Draka Elevator at 1-877-372-5237 for further information.

Tolerances: Inside dimensions from 0 to + 1/16 in.  
joints, corners and adjoining edges to + 1/32 in.  
screw & hole placement to + 1/32 in.

Materials: Hot-dipped, mill-galvanized sheet metal

Wireway and Electrical